

Hindi Letter Worksheets

अक्षरो को ट्रेस करें (Trace The Letter)

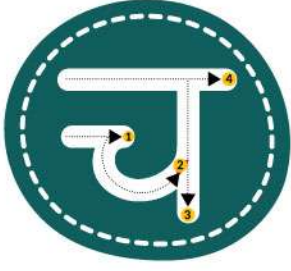

च -(cha) से चावल (cha-a-va-l)



च

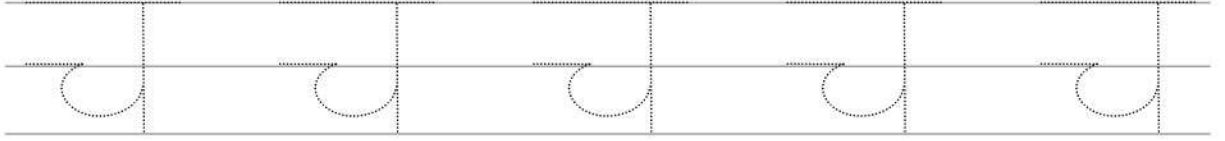

च

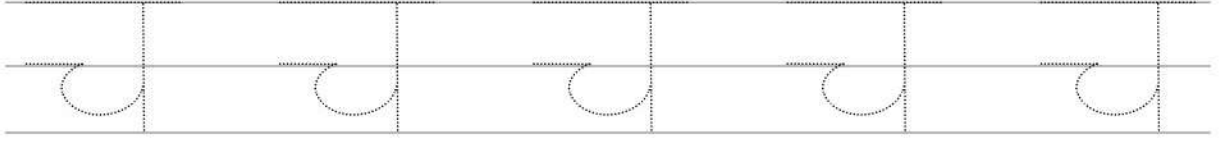

च

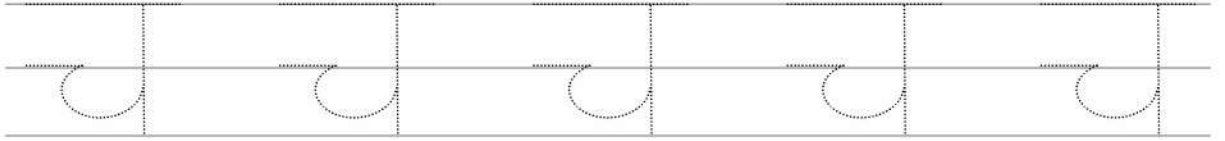

च

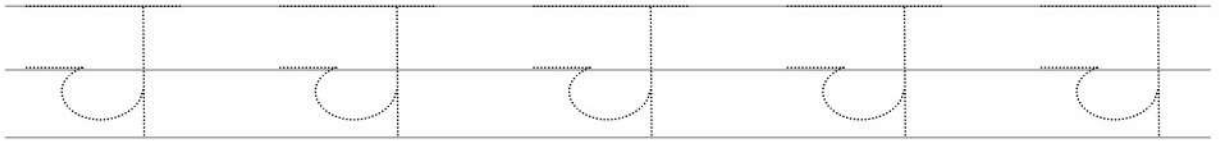

Hindi Letter Worksheets

अक्षरो को ट्रेस करें (Trace The Letter)

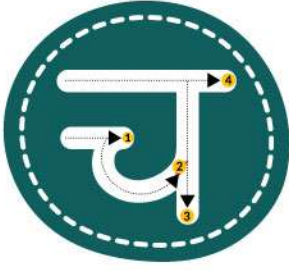

च-(cha) से चूहा (cha-uu-haa)



च

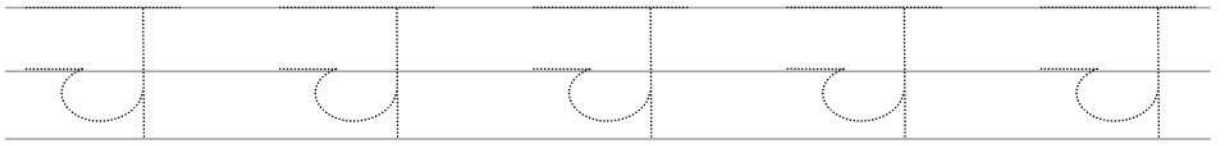

च

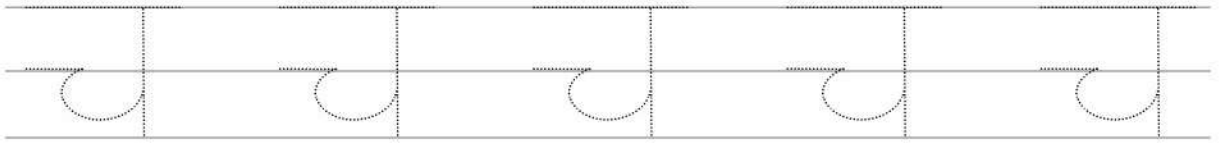

च

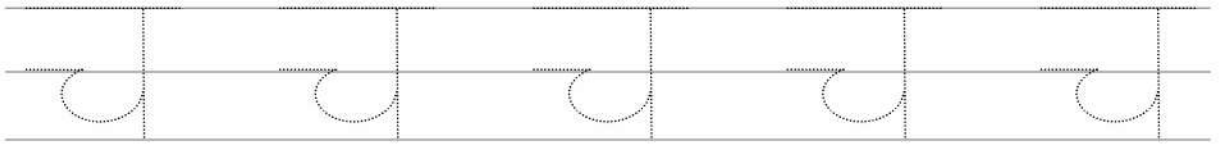

च

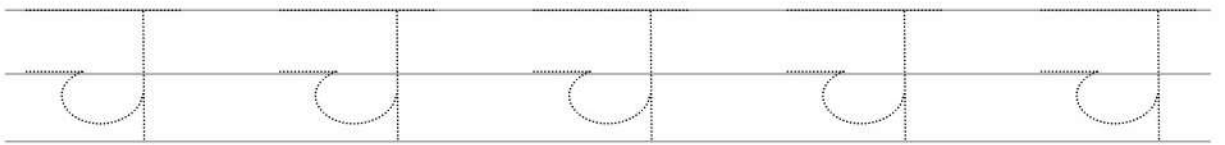

Hindi Letter Worksheets

अक्षरो को ट्रेस करें (Trace The Letter)

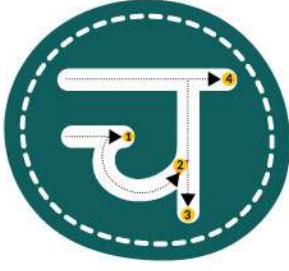

च -(cha) से चटनी (cha-ta-nee)



च

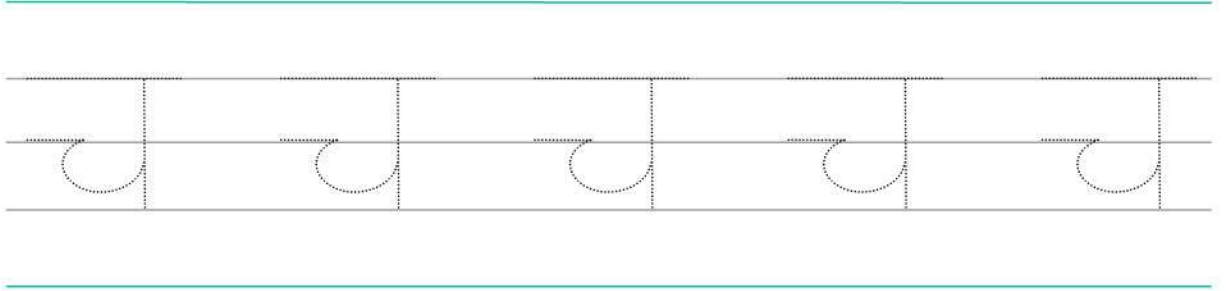

च

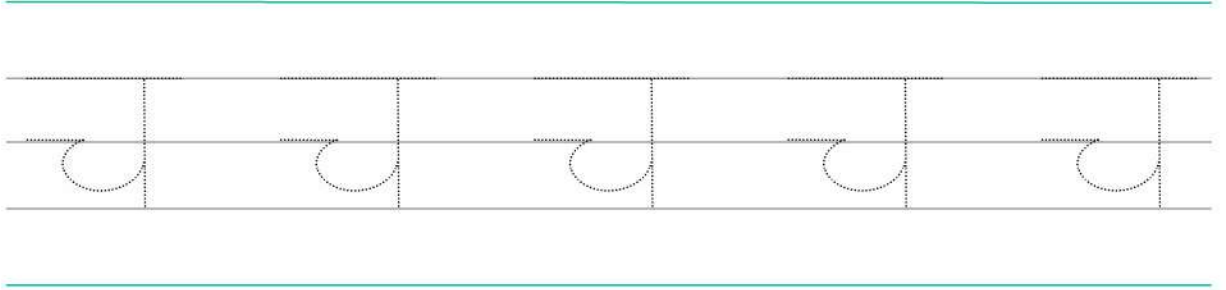

च

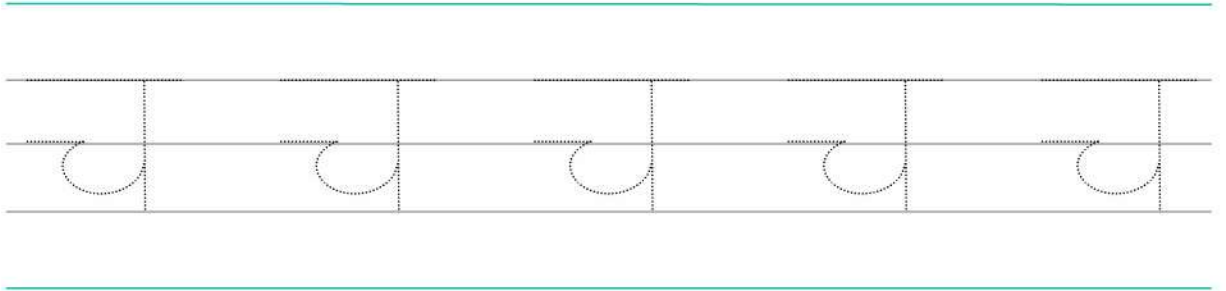

च

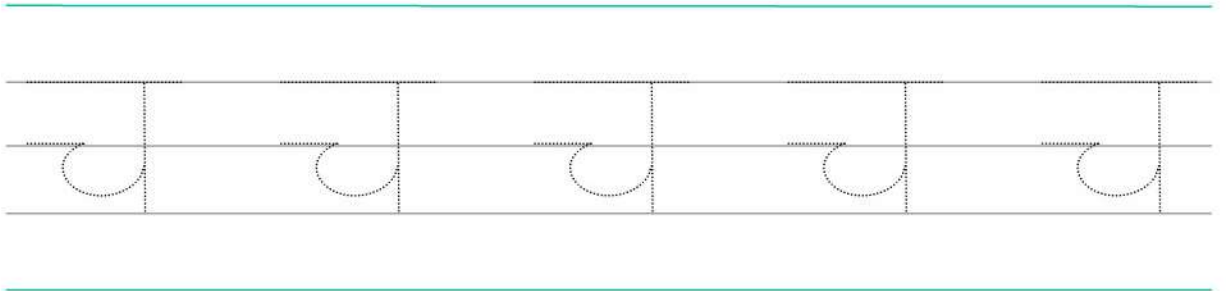

Hindi Letter Worksheets

अक्षरो को ट्रेस करें (Trace The Letter)

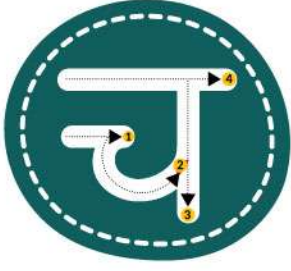

च - (cha) से चींटी (cha-ee-n-tee)



च

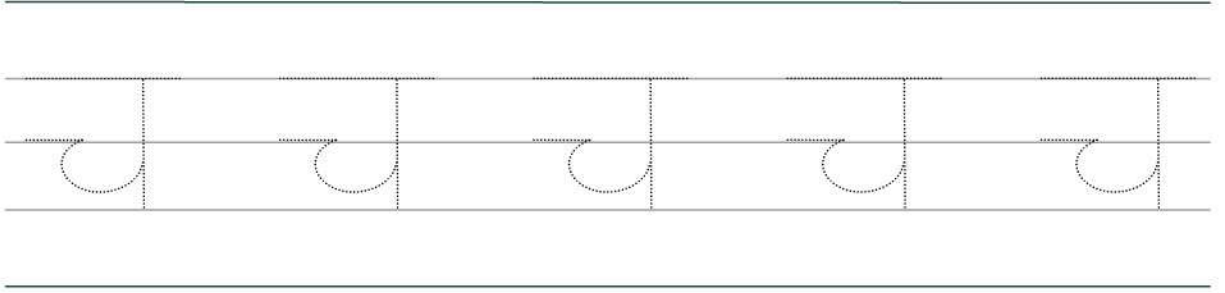

च

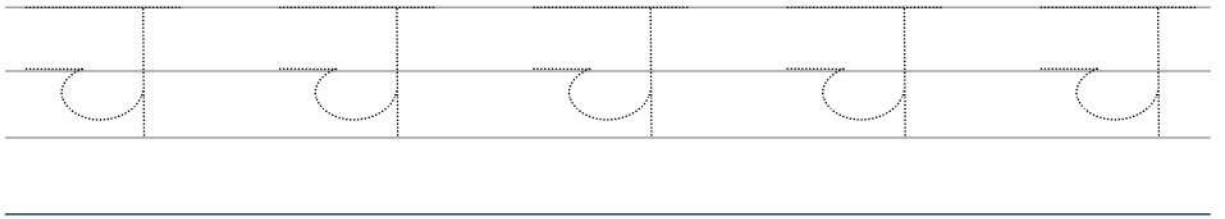

च

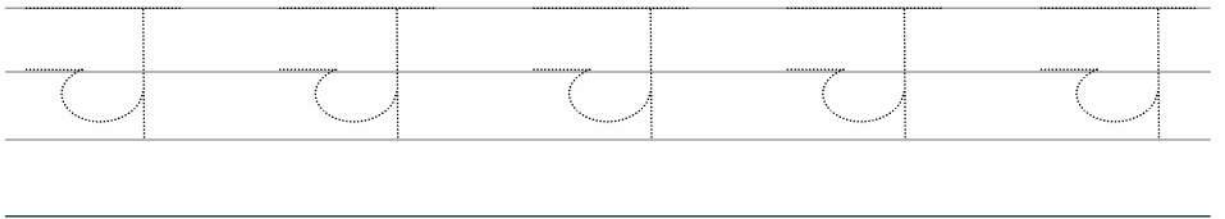

च

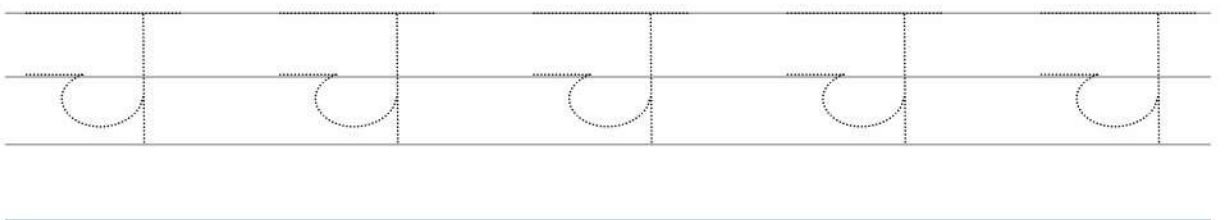

Hindi Letter Worksheets

अक्षरो को ट्रेस करें (Trace The Letter)

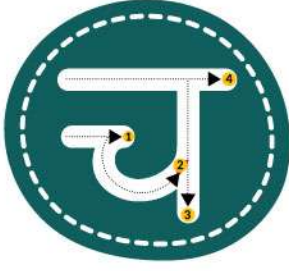

च -(cha) से चक्का (cha-k-kaa)

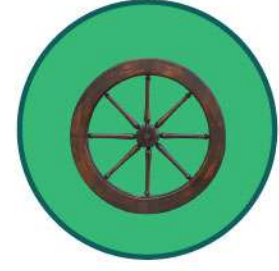

च

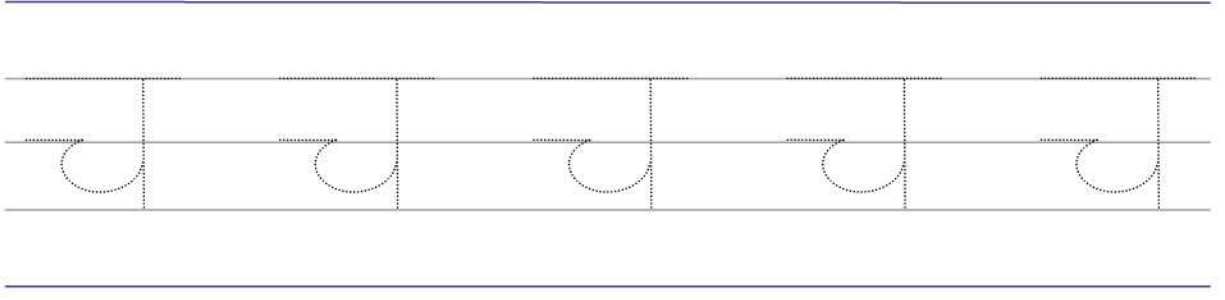

च

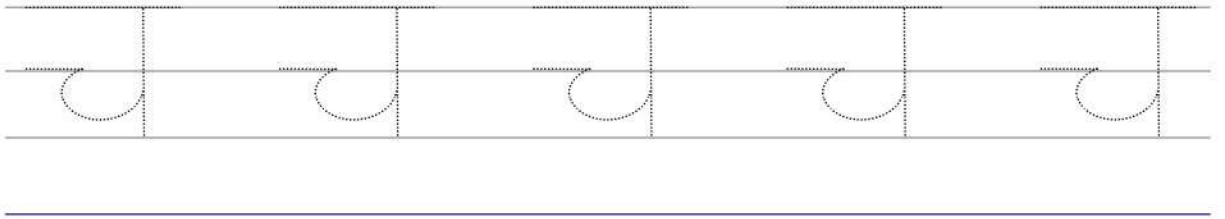

च

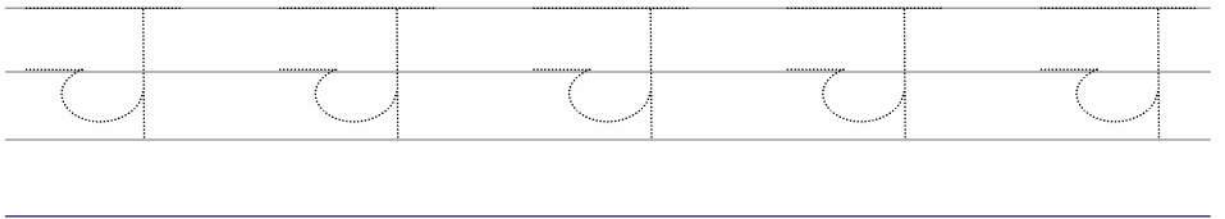

च

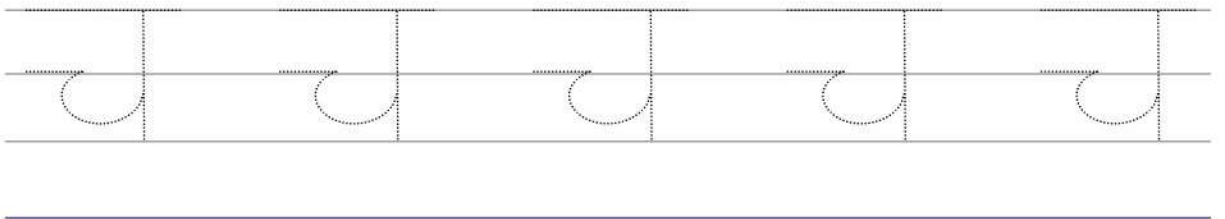

Hindi Letter Worksheets

अक्षरो को ट्रेस करें (Trace The Letter)

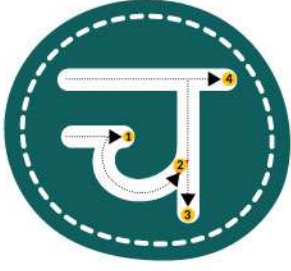

च -(cha) से चरखा (cha-ra-khaa)



च

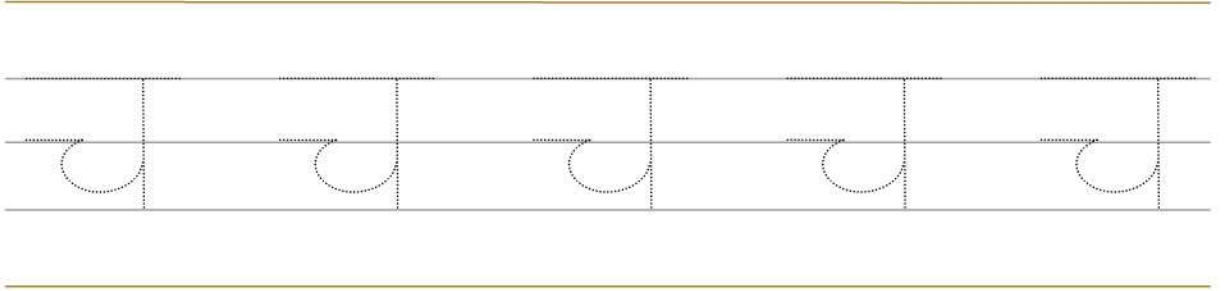

च

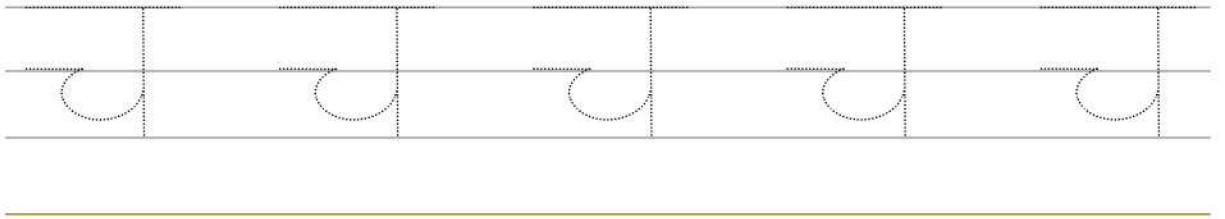

च

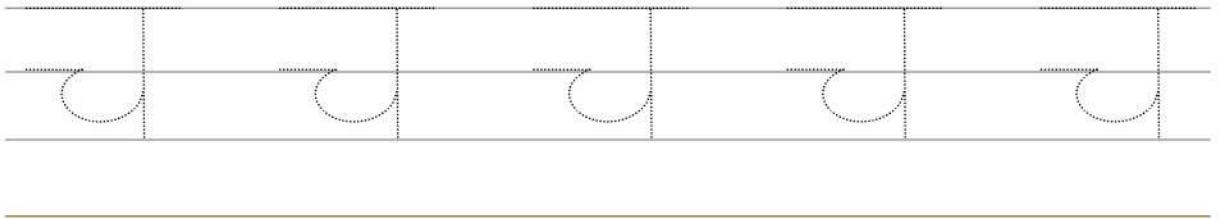

च

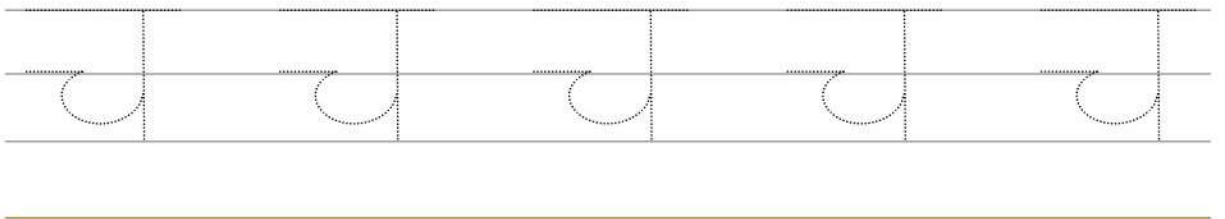

Hindi Letter Worksheets

अक्षरो को ट्रेस करें (Trace The Letter)

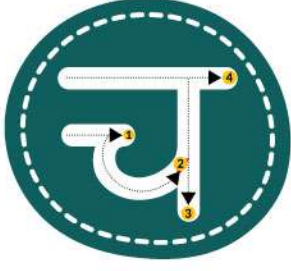

च-(cha) से चीनी (cha-ee-nee)



च

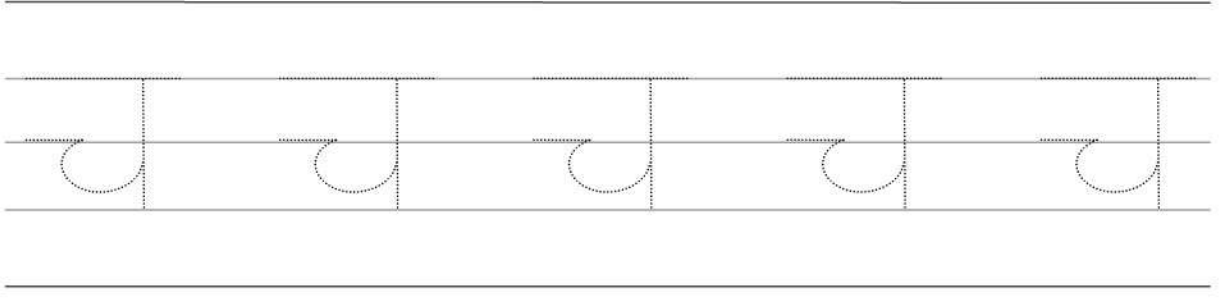

च

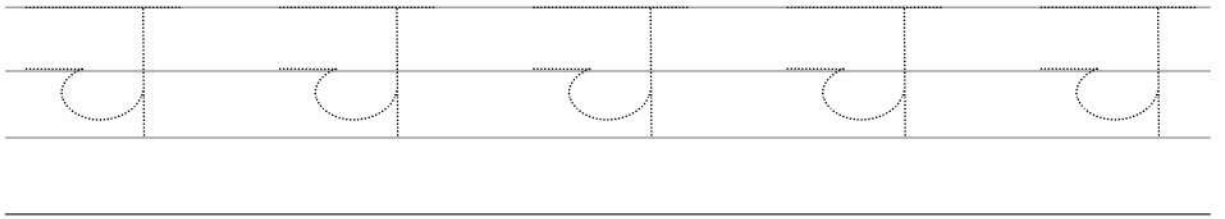

च

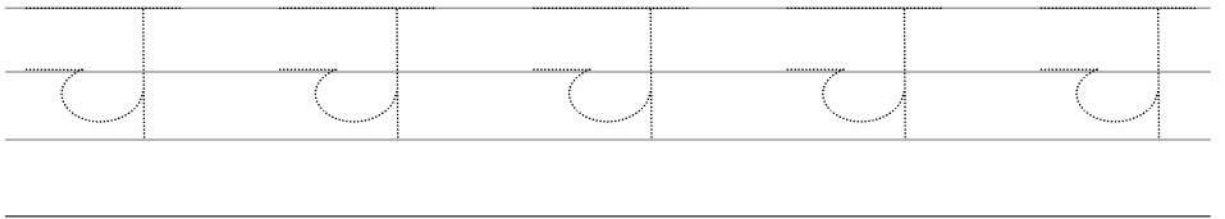

च

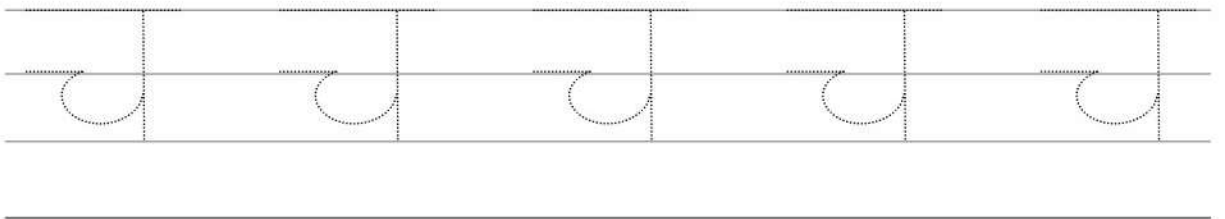

Hindi Letter Worksheets

अक्षरो को ट्रेस करें (Trace The Letter)

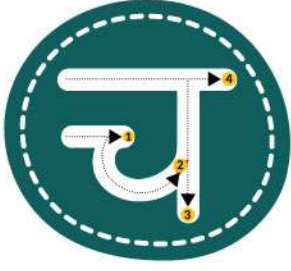

च-(cha) से चमिटा(cha-i-ma-taa)



च

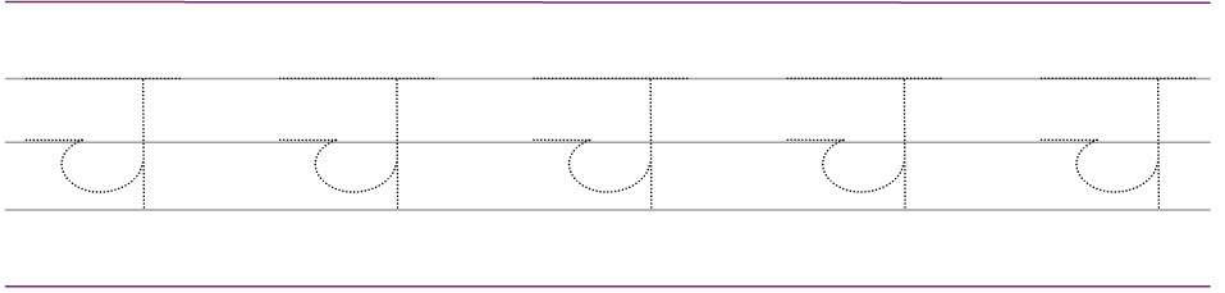

च

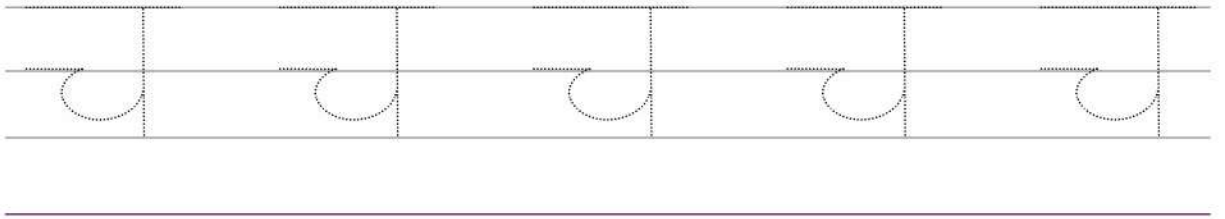

च

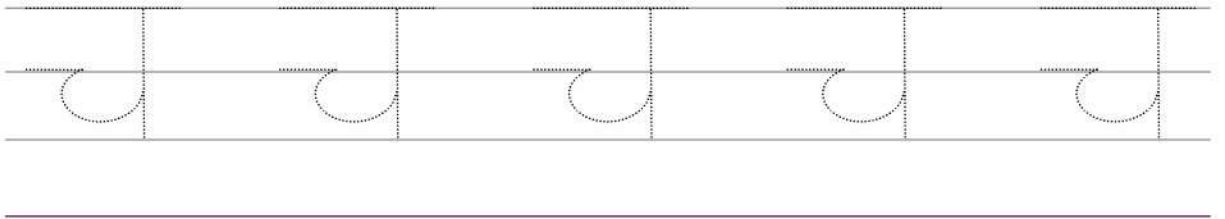

च

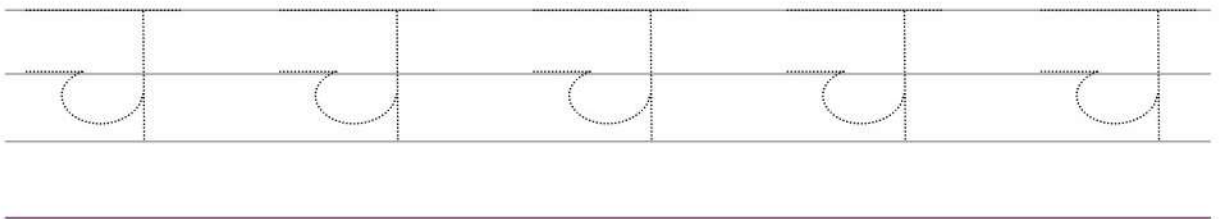

Hindi Letter Worksheets

अक्षरो को ट्रेस करें (Trace The Letter)

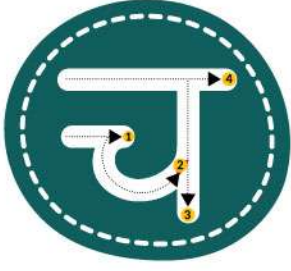

च -(cha) से चीता (cha-ee-taa)



च

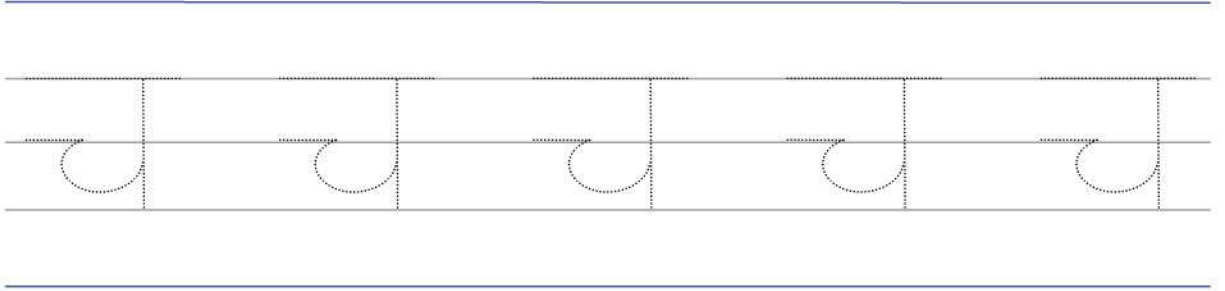

च

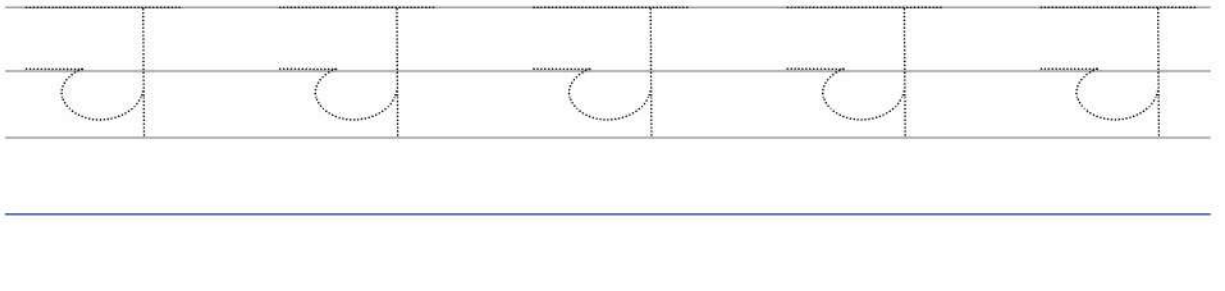

च

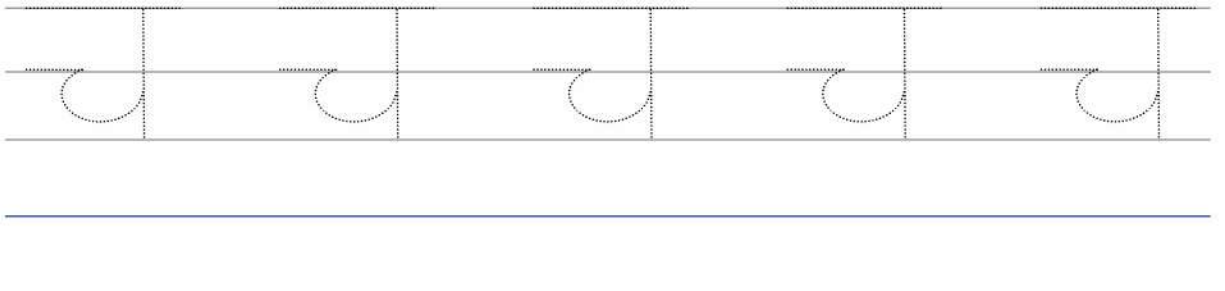

च

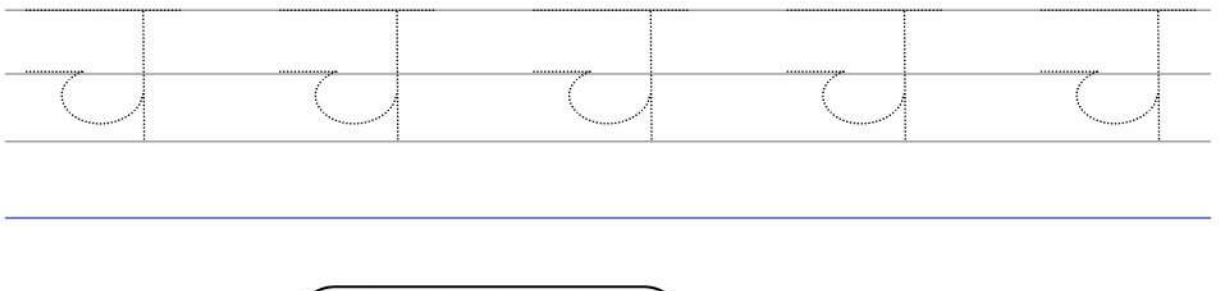

Hindi Letter Worksheets

अक्षरो को ट्रेस करें (Trace The Letter)

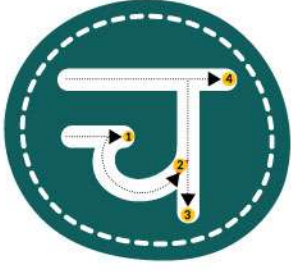

च -(cha) से चमच (cha-ma-ch)



च

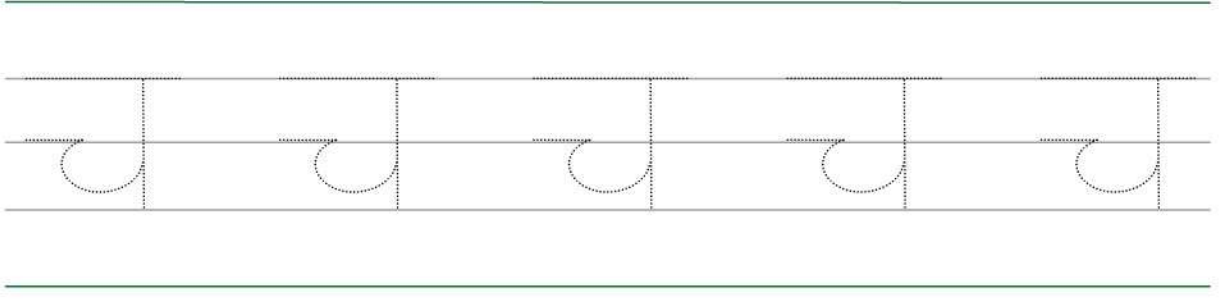

च

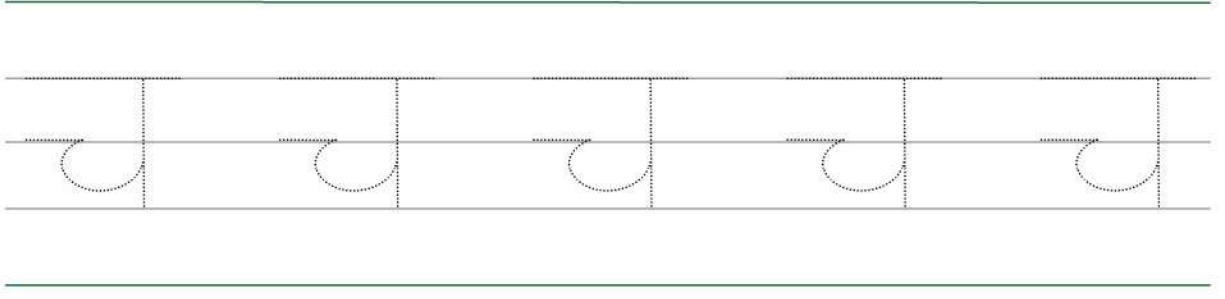

च

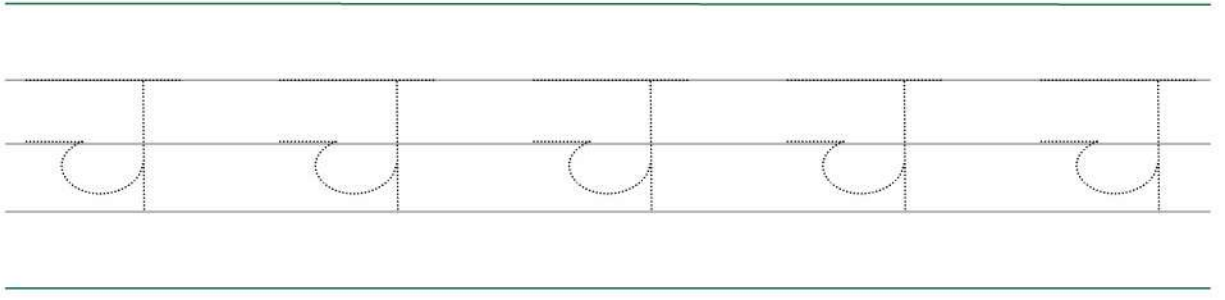

च

